

PIN-FET Optical Receiver Module

Product Indicators (T=±25°C)

Parameter	Test Condition	Unit	Min	Typical Value	Maxi
Operating Wavelength	/	nm	1100	1310	1650
PD Dark Current	Ee=0, VR=5V	nA	/	0.2	0.5
PD Responsibility	R=5V, λ = 1550nm	A/W	0.85	0.9	2
	R=5V, λ = 1550nm	A/W	0.9	0.95	150
Operating Voltage	/	V	/	±5	3.2
Current At+5v	Ee=0, Vopr=±5V	mA	/	16	1.2
Current At-5v	Ee=0, Vopr=±5V	mA	/	3	85

Test Conditions: + 25°C(+/-0.5V De)

Item	Unit	Technical Indicator
Trans-impedance	KΩ	400K
Bandwidth	MHZ	10
Sensitivity	dBm	< -52
Dynamic range	dB	≥25
Noise voltage	mv	≤0.30
Lightless output voltage	V	-1~-2
responsivity	V/μw	0.38
Operation Temperature	°C	-45 ~+70
Package	/	6PIN,8PIN and 14PIN
Fiber type	/	125/250 SM fiber (6/125/250)

Product Package size

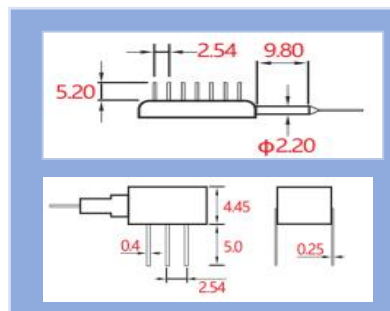

14PIN And Mini6PIN

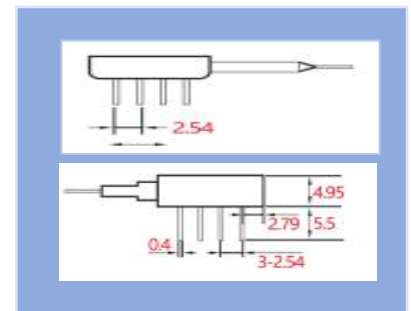

Mini8PIN